

Data Sheet



Article number: 204060M1080A0S

Description: E+G levelling foot

GN 40-60-M10-80-A0-S

Note: S Without nut, External hexagon at the bottom

Measures

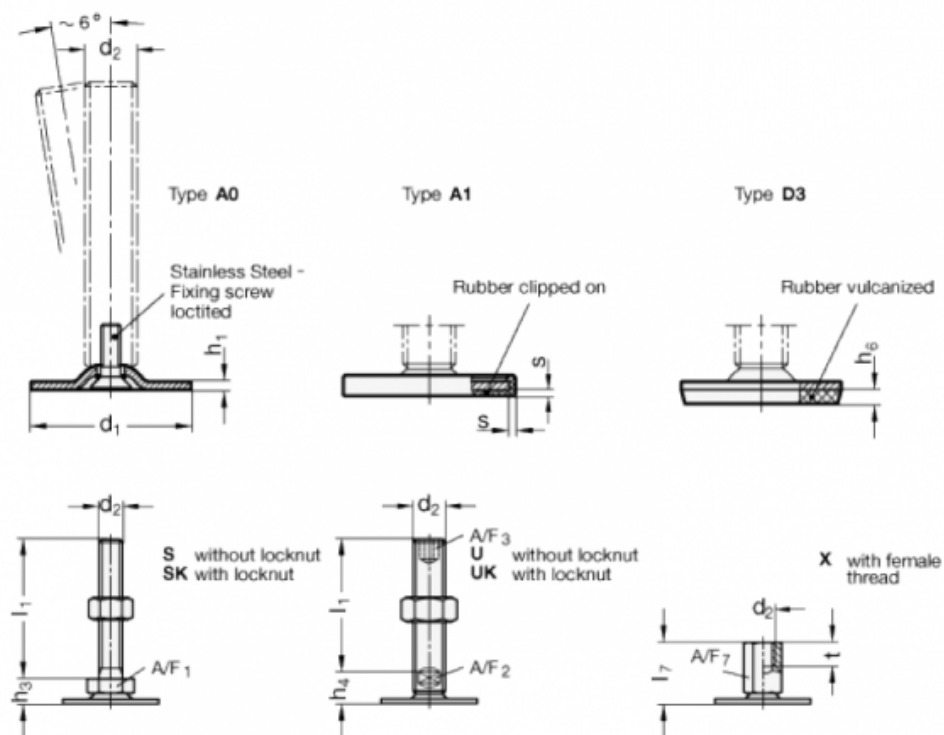

A/F1	=	17
d1	=	60
d2	=	M10
h1	=	2.5
h3	=	11
h6	=	
l1	=	80
s	=	